



















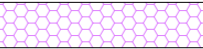



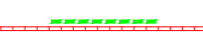

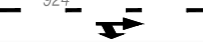

TINGMÄRGID

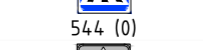
-  Kinnistu piir
-  Projekteeritud tee telgjoon
-  Projekteeritud tee servajooned
-  Projekteeritud murunõlv
-  Projekteeritud sõidutee ab-katend Tüüp 1
-  Projekteeritud sõidutee ab-katend Tüüp 2
-  Projekteeritud sõidutee ab-ülekate Tüüp 3
-  Projekteeritud kõnnitee ab-katend Tüüp 4
-  Projekteeritud kõnnitee ab-katend Tüüp 5
-  Projekteeritud betoonkivisillutuskatend Tüüp 6
-  Projekteeritud täringukividest katend Tüüp 7
-  Projekteeritud haljasalade murukate Tüüp 8
-  Projekteeritud tugipeenar
-  Projekteeritud sõidutee äärekivi 150x290 (h=12 cm)
-  Projekteeritud sõidutee äärekivi 150x290 (h=3 cm)
-  Projekteeritud sõidutee äärekivi 150x290 (h=2 cm)
-  Projekteeritud sõidutee äärekivi 150x290 (h=0 cm)
-  Olemasolev teekattemärgistus
-  Projekteeritud teekattemärgistus
-  Projekteeritud elektriauto laadijaga parkimiskoht
-  Projekteeritud liiklusemärgi post
-  Projekteeritud liiklusemärk suurusgrupiga
-  Olemasolev liiklusemärk
-  Ümbertõstetav liiklusemärk
-  Ümbertõstetava liiklusemärgi uus asukoht
-  Likvideeritavad objektid
-  Varem projekteeritud objektid (Mellson Grupp OÜ töö nr 0619)
-  Varem projekteeritud objektid (Guru Projekt OÜ töö nr DP 287-2022)

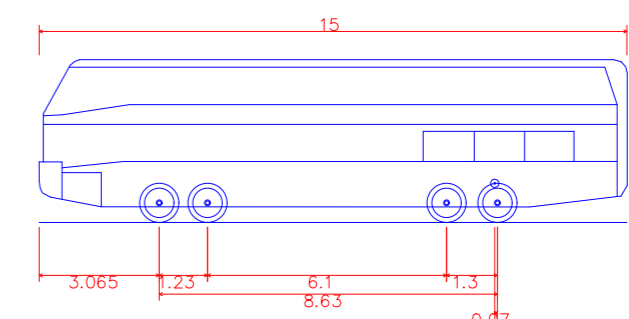

15m 6WS Luxury Coach
 Overall Length 15.000m
 Overall Width 2.500m
 Overall Body Height 4.157m
 Min Body Ground Clearance 0.397m
 Track Width 2.500m
 Lock-to-lock time 5.00s
 Wall to Wall Turning Radius 12.490m

		TELLUJA Transpordiamet, Valge 4, 11413 Tallinn			
INSENERIBOR		PROJEKT Riigitee nr 11106 Kuusalu tee km 0,73-0,85 bussipeatuse ja sõida-pargi parkla ning Tehnika tänav ristmiku põhiprojekt			
PROJEKTEERIS S. Oja		VASTUTAV R. Mäe		STAADIUM Eskiis	
JOONISE NIMI Liikluskorraldus		TÖÖ NR 8824		JOONISE NR 4-01	
KUUP. 11.03.2025		MÕÖTKAVA 1:500		REV 0	
ViaVelo Inseneribüroo OÜ, registrikood 11712139, Valukoja 10, 11415 Tallinn, Tel: 5172182, info@viavelo.ee, www.viavelo.ee, MTR_EEK001192, EPE001115, ELK000063, EEP003424					